

**APPROVAL SHEET**

MODEL NO.: \_\_\_\_\_

**CUSTOMER:**

**CUSTOMER'S APPROVAL:**

AUTHORIZED SIGNATURE/STAMP

DATE

**MANUFACTURER:**

The Fourth Industrial Zone, Luokeng Village, Xiaotie District, Xiaojinkou Town, Huizhou City, Guangdong Province, China

Tel: 0752-7213069/7213070

Fax: 0752-7213065

Submitted by:

Approved by:

Date:

## Performance Specification

Model	Marking	V <sub>max</sub> (V dc)	I <sub>max</sub> (A)	I <sub>hold</sub> @23°C (A)	I <sub>trip</sub> @23°C (A)	P <sub>d</sub> Typ. (W)	Maximum Time To Trip		Resistance	
							Current (A)	Time (Sec)	R <sub>i min</sub> (Ω)	R <sub>1max</sub> (Ω)
SMD3425R200SF60	R60 200	60	20	2.00	4.00	2.5	8.0	10.0	0.040	0.200
SMD3425R200SF72	R72 200	72	20	2.00	4.00	2.5	8.0	10.0	0.040	0.200
SMD3425R260SF60	R60 260	60	20	2.60	5.20	2.5	8.0	10.0	0.020	0.120
SMD3425R300SF	R60 300	36	20	3.00	6.00	2.5	8.0	20.0	0.010	0.060

V<sub>max</sub> = Maximum operating voltage device can withstand without damage at rated current (I<sub>max</sub>).

I<sub>max</sub> = Maximum fault current device can withstand without damage at rated voltage (V<sub>max</sub>).

I<sub>hold</sub> = Hold Current. Maximum current device will not trip in 23°C still air.

I<sub>trip</sub> = Trip Current. Minimum current at which the device will always trip in 23°C still air.

P<sub>d</sub> = Power dissipation when device is in the tripped state in 23°C still air environment at rated voltage.

R<sub>i min</sub>/max = Minimum/Maximum device resistance prior to tripping at 23°C.

R<sub>1max</sub> = Maximum device resistance is measured one hour post reflow.

CAUTION : Operation beyond the specified ratings may result in damage and possible arcing and flame.

Value specified is determined by using the PWB with 0.090"×1.5oz copper traces .



Caution : Operation beyond the specified rating may result in damage and possible arcing and flame .

Specifications are subject to change without notice .

## Environmental Specifications

Test	Conditions	Resistance change
Passive aging	+85°C, 1000 hrs.	I HOLD/I TRIP PASS
Humidity aging	+85°C, 85% R.H. , 168 hours	I HOLD/I TRIP PASS
Thermal shock	+85°C to -40°C, 20 times	I HOLD/I TRIP PASS
Resistance to solvent	MIL-STD-202, Method 215	No change
Vibration	MIL-STD-202, Method 201	No change
Ambient operating conditions : - 40 °C to +85 °C		
Maximum surface temperature of the device in the tripped state is 125 °C		

## Agency Approval and Environmental Compliance

Agency	File Number	Regulation	Standard
UL	pending		2002/95/EC
TUV	pending		EN14582

## Thermal Derating Chart

Recommended Hold Current(A) at Ambient Temperature(°C)

Model	Ambient Operation Temperature								
	-40°C	-20°C	0°C	23°C	40°C	50°C	60°C	70°C	85°C
SMD3425R200SF60/72	3.07	2.73	2.39	2.00	1.71	1.54	1.37	1.20	0.95
SMD3425R260SF60	4.01	3.56	3.12	2.60	2.22	2.00	1.77	1.55	1.21
SMD3425R300SF	4.43	3.98	3.52	3.00	2.61	2.39	2.16	1.93	1.59

## Thermal Derating Curve

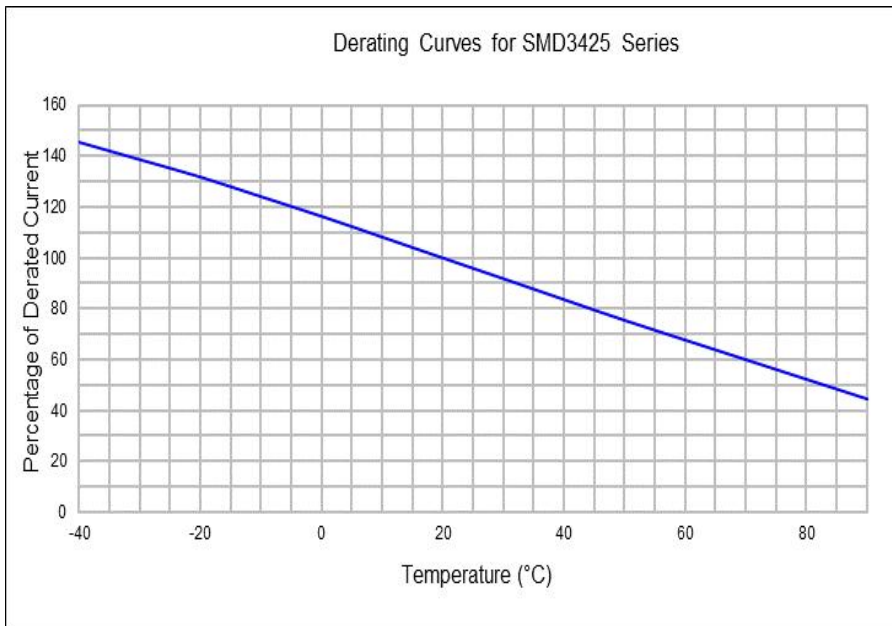

## Average Time-Current Curve

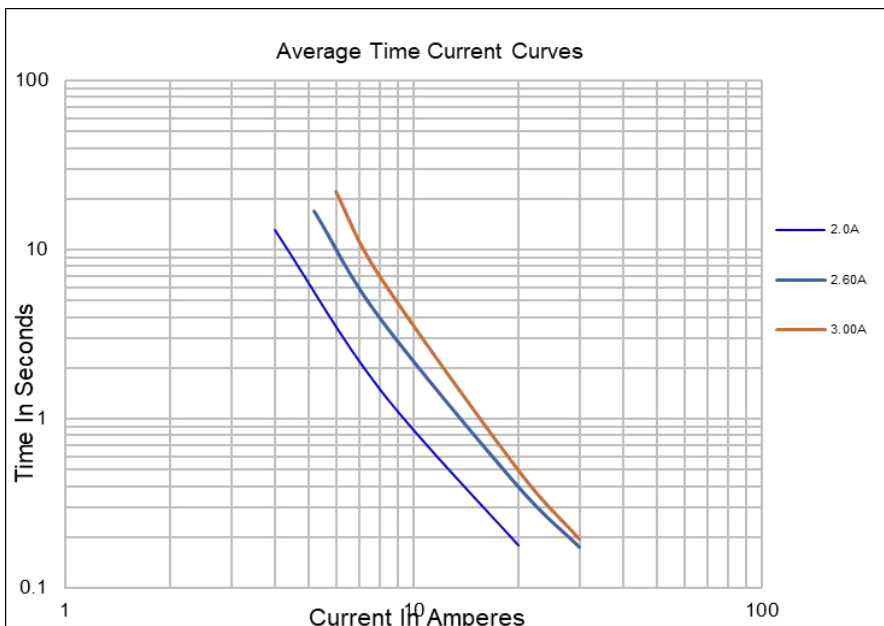

**Soldering Parameters**

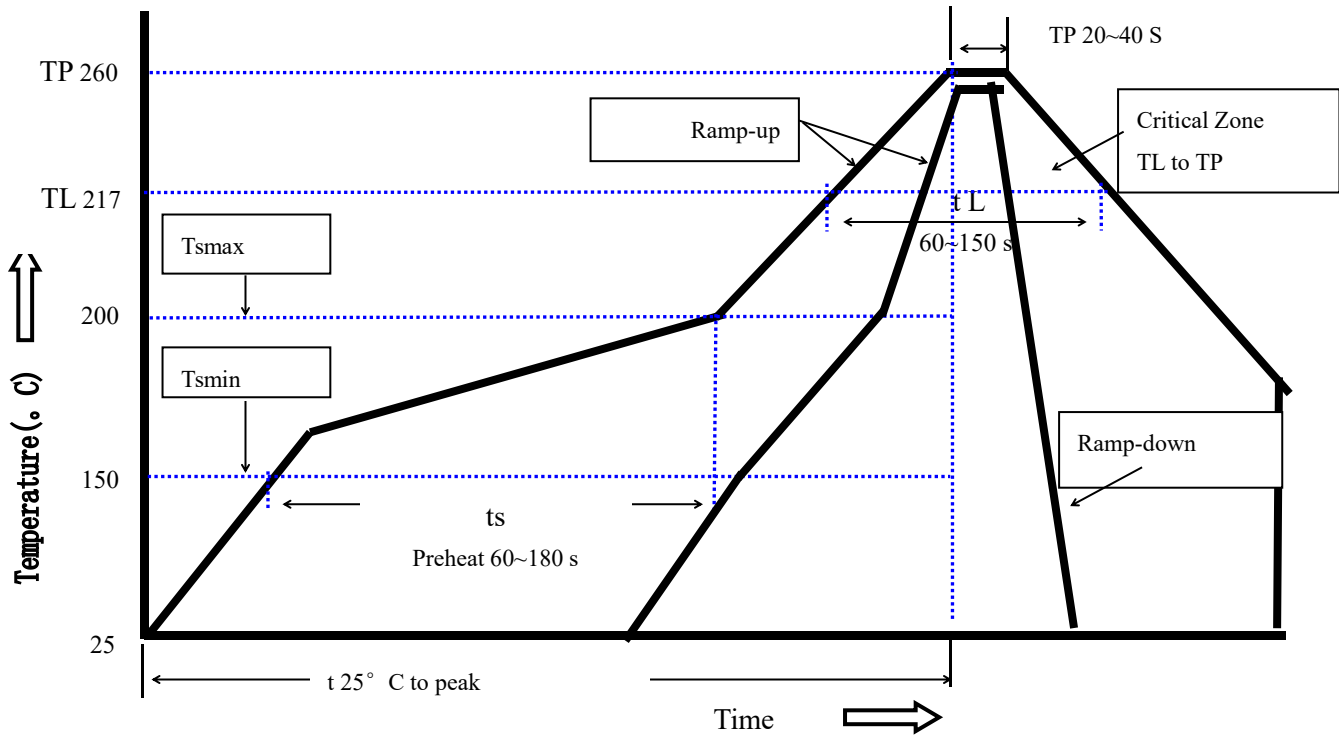

Profile Feature	Pb-Free Assembly
Average Ramp-Up Rate(Ts max to T p)	3°C/second max.
Preheat	
-Temperature Min(Ts min)	150°C
-Temperature Max(Ts max)	200°C
-Time(Ts min to Ts max)	60~180 seconds
Time maintained above:	
-Temperature(TL)	217°C
-Time(tL)	60~150 seconds
Peak Temperature(Tp)	260°C
Ramp-Down Rate	6°C/second max.
Time 25°C to Peak Temperature	8 minutes max
Storage Condition	遮光密封

Recommended reflow methods: IR, vapor phase oven, hot air oven, N2 environment for lead-free

Recommended maximum paste thickness is 0.25mm

Devices can be cleaned using standard industry methods and solvents.

Note 1: All temperature refer to topside of the package, measured on the package body surface.

Note 2: If reflow temperatures exceed the recommended profile, devices may not meet the performance requirements.

**Physical Dimensions(mm.)**

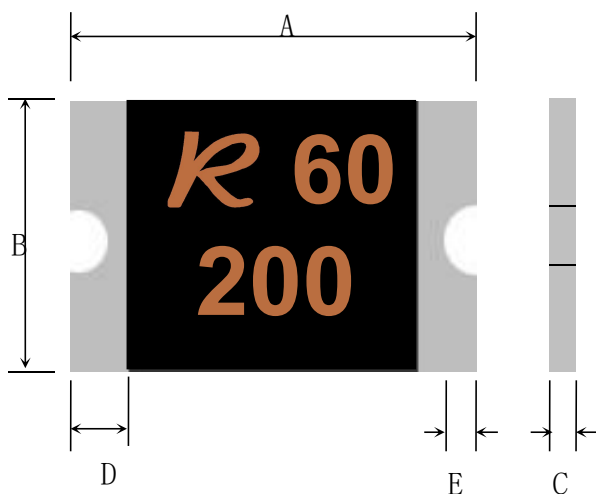

Model	A		B		C		D	E
	Min.	Max.	Min.	Max.	Min.	Max.	Min.	Min.
SMD3425R200SF60	8.30	9.00	6.00	6.7	1.0	2.0	0.30	0.25
SMD3425R200SF72	8.30	9.00	6.00	6.7	1.2	2.5	0.30	0.25
SMD3425R260SF60	8.30	9.00	6.00	6.7	1.0	2.0	0.30	0.25
SMD3425R300SF	8.30	9.00	6.00	6.7	1.0	2.0	0.30	0.25

**Termination Pad Characteristics**

Terminal pad materials: Tin-plated Nickel-Copper

Terminal pad solder ability: Meets EIA specification RS186-9E and ANSI/J-STD-002 Category 3.

**Recommended Pad Layout (mm.)**

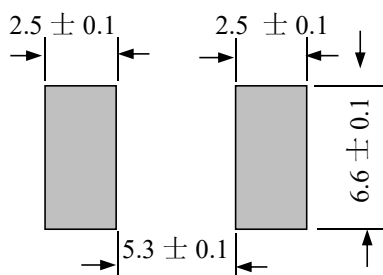

注：在此印锡面积条件下，推荐钢网厚度为 $\geq 0.12\text{MM}$ (钢网厚度不够要增大刷锡面积)

**Packaging Quantity**

Part Number	Quantity
SMD3425R200SF/60	1500 pcs/reel
SMD3425R200SF/72	1500 pcs/reel
SMD3425R260SF/60	1500 pcs/reel
SMD3425R300SF	1500 pcs/reel

Tape & reel packaging per EIA481-1

**Tape And Reel Specifications (mm)**

Governing Specifications		EIA 481-2
W	16.00 ± 0.3	
P0	4.00 ± 0.10	
P1	8.00 ± 0.10	
P2	2.00 ± 0.05	
A0	7.00 ± 0.10	
B0	9.50 ± 0.10	
B1max.	12.10	
D0	1.50 + 0.1, -0	
F	7.50 ± 0.05	
E1	1.75 ± 0.10	
E2min.	14.25	
T	0.60	
T1max.	0.10	
K0	2.2	
Leader min.	390	
Trailer min.	160	
Reel Dimensions		
A max.	180	
N min.	60	
W1	16.40 ± 0.5	
W2	22.40	

EIA Tape Component Dimensions

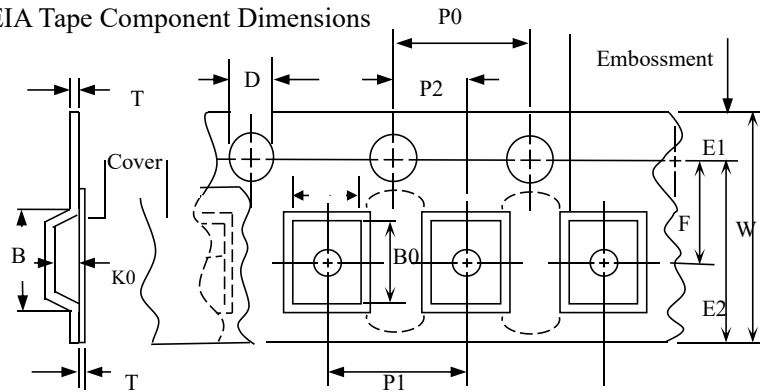

EIA Reel Dimensions

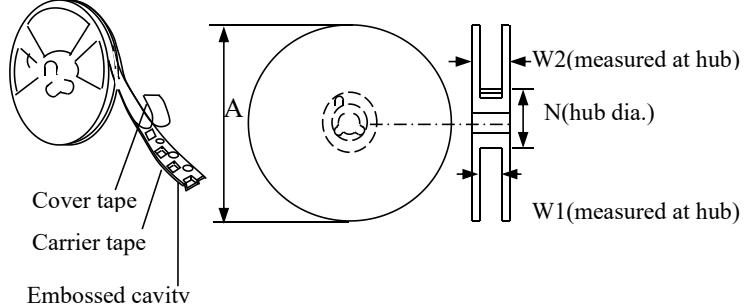

**Storage And Handling**

- Storage conditions: 遮光密封
- Devices may not meet specified performance if storage conditions are exceeded.

**Part Number System**

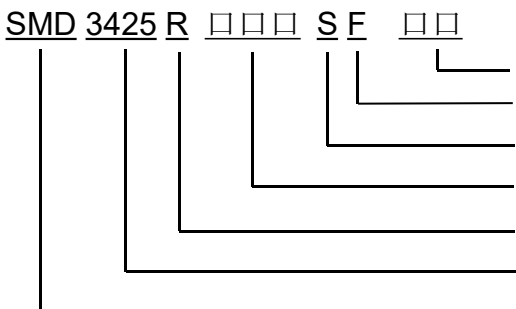

special voltage Rating(Optional)

Lead-Free

Tin-plated Nickel-Copper

Holding Current Rating

Da Rong

Device Dimensions: Length/width(Unit:1/100 inch) Size 8663mm /3425inch

Surface Mount Device

## 注意事项

PPTC 使用注意事项:

- PPTC 为热敏元件，对环境温度比较敏感，建议在 PPTC 周围不要设计热源元件，环境温度最高控制在 85℃ 以下，尽量减少外部热源的影响，否则会影响产品性能导致焊后电阻大于规格。
- 请在规格书规定的参数下 (<10%) 使用，超出电压电流规格值，会导致 PPTC 出现电弧，阻值升高，甚至烧片。
- 规格书的电气特性，均是基于在大容指定测试板经过一次回流焊之后的测试；如果客户有二次回流焊或者注塑点胶等其他热工序，会对上述参数有一定程度的衰减，需要验证其适用性。
- PPTC 设备在故障状态下会发生热膨胀。如果 PPTC 装置安装或放置在 PPTC 装置与周围材料（如覆盖材料、包装材料、封装材料等）之间的空间不足的应用中，将对热膨胀产生抑制作用。挤压、扭曲、弯曲和其他类型的机械应力也会对 PPTC 设备的性能产生不利影响，不得使用或施加。
- PPTC 贴片产品是为 SMT 工艺设计的封装形式，焊接工艺为回流焊；要求客户遵守我们推荐的焊盘布局和回流焊配置文件。不正确的电路板布局或回流配置可能会对 PPTC 的可焊性性能产生负面影响。焊接工艺可参考大容推荐的回流焊曲线。如果回流焊温度超过推荐的值，PPTC 将有可能受到损伤。使用手工焊及波峰焊接 PPTC 可能会导致产品焊后电阻超出规格。
- 某些注塑料、单组份、双组份固化胶粘剂、硅胶、特种润滑理基脂、侵蚀性溶剂、石蜡污染 PPTC 材料破坏芯片，需要对注塑料胶料、石蜡等材料牌号以及应用参数（如温度、时间等）进行验证，以确保产品及工艺的匹配性，确认不会影响 PPTC 性能之后方可使用。PPTC 在充电线端应用中，建议使用 PP 类材料做内膜，禁止使用 TPE 类与 PVC 类等材料做内膜。
- PPTC 贴装或使用过程中，不建议使用洗板水或其他清洗剂进行清洗。如必须使用，需要验证各类清洗剂、洗板水以及溶剂的适用性，确认不会影响 PPTC 性能之后方可使用。已知对 PPTC 有影响的化学药品包括但不限于醚类、苯类、酮类以及脂类等较强溶解性、破坏性的有机化合物，清洗后将产品放置于敞开的环境中至少 24 小时，将残留的溶剂进行充分的挥发。
- 装配过程中，避免用暴力砸、挤、压、拉、扭、刺等方式作用 PPTC 本体，以免引起 PPTC 性能衰减。
- PPTC 元件是为电路中偶尔出现的过流而设计的，不建议用在连续且持续过流、重复故障的电路中（此类故障情况可能是由连接器的错误引脚连接引起的），或过大范围跳闸事件可能发生时，不得使用。
- 大容 SMD PPTC 产品为遮光密封包装。客户如在库存中发现有包装破损的，立即将产品隔离处理；使用时如有余料，需恢复之前包装状态，做遮光密封保存，否则会影响产品性能导致焊后电阻大于规格。
- 产品废弃时，可按照一般电子废弃物处理，具体材料组成可参见 MSDS

如果以上注意事项的任何项目未得到遵守，则免除所有的责任。